

**HALO LED Module 600 Series
For New and Existing Installations**

The Halo LED ML7068xx modules are designed for retrofit applications with an Edison screw base adapter (included with the module) for use in existing housings OR may also be used in new construction with the LED dedicated housing Series H750x. Halo LED 600 Series modules deliver in the range of 400-760 lumens (depending upon the trim and selected color temp); and the 600 Series offers selection of four color temperatures: 2700K, 3000K, 3500K, 4000K. Halo LED offers a superior optical design that yields productive beam lumens, good cutoff and low glare. The Halo LED also exceeds high efficacy requirements (with designated trims) for Title 24-2008 and IECC-2009.

DESIGN FEATURES

Exceeds the light output and distribution of a 65W BR30 incandescent lamp or an 18W compact fluorescent luminaire, while consuming less than 14 watts.

Dimming

The HALO LED luminaire is dimmable to 15% with standard 120V incandescent, magnetic low voltage, and electronic low voltage dimmers (or to 5% using dimmers with low end trim adjustment.) Standard incandescent dimmers require a minimum load of typically >40 watts on the circuit for full range dimming performance (four LED modules). For dimming with digital (smart) multi-location dimmers or when dimming fewer than four LED modules, electronic low voltage dimmers are required (ELV dimmers need a neutral connection in the wallbox).

Quality of Light

Halo 600 Series provides excellent color rendering (80 CRI), and a selection of four color temperatures (2700K, 3000K, 3500K and 4000K). CRI and color temperature performance conform to parameters established by ENERGY STAR® SSL standards (refer to ANSI-C78.377 - 2008 for CCT specifications). LED's have virtually no ultraviolet and minimal infrared wavelengths, and they do not emit heat like conventional lamps.

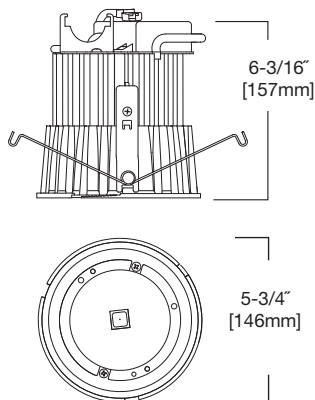

Optical Design

Optical design yields productive beam lumens, 50° cutoff, and low glare.

Life

Rated for 50,000 hours at 70% lumen maintenance.

Compatibility

The Halo ML7068xx LED modules are designed for use in the dedicated H750x series housings OR for retrofit applications in existing Halo or ALL-PRO™ H7/ET7/EI7 housings. The Halo LED module is designed for use in either IC (insulated ceiling) or non-IC construction. Compatible HALO and ALL-PRO housings include model numbers:

- Dedicated LED Housing: H750x Series
- Halo Housings: H7x Series
- ALL-PRO Housings: ET7x and EI7x Series

Screw Base Adapter

Edison screw-base adapter supplied with module allows simple wiring connection to existing housing.

Module Construction

Durable die-cast and extruded aluminum construction conducts heat away from the LED keeping the junction temperatures below specified maximums even when installed in insulated ceiling environments.

Air-Tite™ Rating

The Halo LED module has passed restricted air flow testing, and now qualifies any housing to meet airtight building codes. Certified under ASTM-E283 standards.

LED Driver

The LED module is controlled by a high efficiency driver with a power factor of >.90 at an input power of 120V, 50/60Hz. Driver has integral thermal protection in the event of over temperature or internal failure.

Warranty

Cooper Lighting provides a three year limited warranty on the Halo LED Luminaire which includes the LED Module, LED Recessed Housing and LED trims.

Catalog #		Type
Project		
Comments		Date
Prepared by		

Distributed by: Green-Energy-Products.Com, LLC

305.251.9630 - 800.639.8796

Info@green-energy-products.com

LED Module in New or Existing Construction – Housings other than Halo or All-Pro

If used in recessed housings other than Halo or All-Pro the Cooper Lighting 3-year warranty applies to the LED Module and Trim only. As with any electrical installation, a qualified electrician must ensure compatibility of use with a particular housing; this includes all applicable national and local electrical and building codes. Installer is responsible to securely retain the LED Module and Trim in a housing at time of installation.

Labels

- UL/cUL Listed
- Meets following requirements:
- State of California Title 24-2008 High Efficacy Compliant (with designated trims)
- International Energy Conservation Code (IECC) 2009 High Efficacy Compliant (with designated trims)
- Washington State Energy Code - AIR-TITE™
- New York State Energy Conservation Construction Code AIR-TITE™

Accessories

- Oversize Trim Rings (Goof Rings) - OT400P and OT403P oversize trim rings are installed behind the Halo LED trim ring to aid in masking ceiling irregularities and cut-out errors.
- H277 –The H277 Step-down transformer for use with non-IC housings (H7T, H7TNB, H750T, H750TCP, H750TD010) and LED Module.
- H347 –The H347 Step-down transformer for use with non-IC housings (H7T, H7TNB, H750T, H750TCP, H750TD010) and LED Module.
- ML7RAB - Retrofit Adapter Band for retrofit of Halo LED Modules into 6" nominal housings that do not have torsion spring receivers for module installation. The ML7RAB kit supplies parts to retrofit four housings and includes: four adapters with instructions, metal piercing screws, and locking wire nuts.



**ML706827
600 Series LED
Dimmable Module**

**2700°K Correlated
Color Temperature**

49X_Series Trims

**6" LED Module and Trim
For New Construction OR
Retrofit Applications**

600 Series Energy Data:

(Values at non-dimming line voltage)

Minimum Starting Temp: -30°C (-22°F)

EMI/RFI: FCC Title 47 CFR, Part 18, Class B (Consumer)

Sound Rating:	Class A standards
Input Voltage:	120V
Power Factor:	>0.90
Input Frequency:	50/60Hz
THD:	<20%
Rated Wattage:	13.8W
Input Power:	13.8W
Input Current:	126mA
Maximum IC (Insulated Ceiling) Ambient Continuous Operating Temperature:	25°C (77°F)
Maximum Non-IC Ambient Continuous Operating Temperature:	40°C (104°F)

600 Series Summary Lighting Data:

Lumen range:400-760
Lumens per watt:55 max.
Watts at 120VAC:13.8
Color	
Correlated Color Temperature (CCT):2700-4000K
Color Rendering Index (CRI, Ra):80



Qualified & Compliant with designated LED modules and trims.



Correlated Color Temperature

ENERGY STAR® SSL
Nominal CCT

LED Module

Also Available

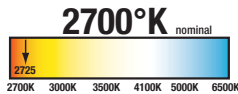

ML706827

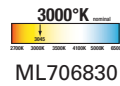

ML706830

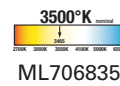

ML706835

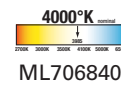

ML706840

ML7RAB Retrofit Adapter Band for Housings without Torsion Spring Receivers

In many retrofit installations the existing (6" nominal aperture) housings have Torsion Spring Receivers that are used to install trims. Many of these housings will allow direct installation of the LED Module. In some existing installations housings do not have torsion spring receivers. The ML7RAB was designed for installation into those housings. The ML7RAB kit can retrofit four non-torsion spring housings; the kit includes:

- 4 – Retrofit Adapter Bands (1 per retrofit housing)
- 16 – Metal-piercing screws (4 per adapter)
- 8 – Retrofit Locking Wire Nuts (2 per adapter)

ML7RAB Retrofit Adapter Band
(Four Adapters per Box)

TRM490 Thin Profile Trim Ring (Optional Accessory)

- Die-cast trim ring
- Thin trim ring provides a more subtle ceiling appearance
- Purchase as accessory and discard ring supplied with trim
- Trim ring height of .120" at OD and .180" at ID
 - TRM490BK = Black
 - TRM490PC = Polished Chrome
 - TRM490SN = Satin Nickel
 - TRM490TBZ = Tuscan Bronze
 - TRM490WH = White

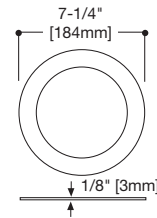
TRM490
Optional Accessory
Thin Profile Trim Ring

Oversize Trim Rings

For use when ceiling opening is irregular or cut too large. The oversized trim ring is installed behind the Halo LED trim ring to mask irregularities or cutout errors of the ceiling opening.

- OT400P = Oversize White Metal Trim Ring 6" ID x 9-1/4" OD
- OT403P = Oversize White Plastic Trim Ring 6" ID x 8" OD

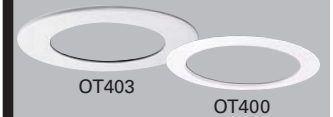
OT400, OT403
Oversize Trim Rings

Step Down Transformer

H277= Transformer - Steps 277 line voltage down to 120 volts. Attaches to knockout on junction box and is 300VA (18 modules max.) rated. H277 is a UL Recognized Component that is listed for use under the luminaire UL/cUL listing for use with non-IC housings (H750T, H750TCP, H7T, H7TNB, H7RT, H750TD010, H750RTD010 and LED Module)

H347= Transformer - Steps 347 line voltage down to 120 volts. Attaches to knockout on junction box and is 75VA (4 modules max.) rated. H347 is a CSA/UL Listed Component that is listed for use under the luminaire UL/cUL listing for use with non-IC housings (H750T, H750TCP, H7T, H7TNB, H7RT, H750TD010, H750RTD010 and LED Module) (Note: No 347V dimmers currently available)

Transformer with Dimmer /Switch on Secondary

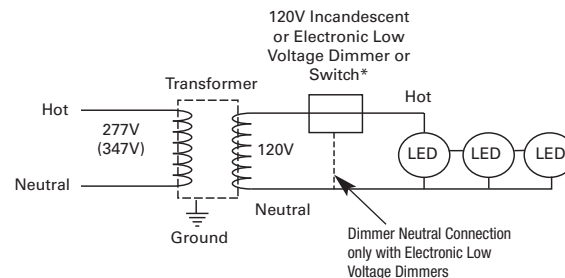
H277
277V Step Down Transformer

Transformer with Dimmer /Switch on Primary

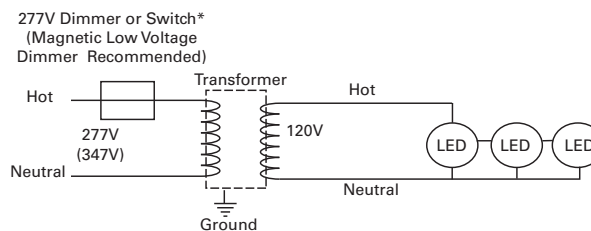
H347
347V Step Down Transformer

Transformer Load - H277 (300VA)

1. H277Transformer at full loading consumes a maximum of 16W of power
2. When dimmer or switch is on the secondary (120V) side of the transformer, power is consumed by the transformer when the dimmer or switch is in "OFF" mode at 6.5W and in "ON" mode at 16W maximum with full loading.
3. When a dimmer or switch is on the primary (277V) side of the transformer, power is consumed only in "ON" mode to a maximum of 16W under full loading.

Transformer Load - H347 (75VA)

1. H347Transformer at full loading consumes a maximum of 15W of power
2. When dimmer or switch is on the secondary (120V) side of the transformer, power is consumed by the transformer when the dimmer or switch is in "OFF" mode at 2.5W and in "ON" mode at 15W maximum with full loading.
3. When a dimmer or switch is on the primary (347V) side of the transformer, power is consumed only in "ON" mode to a maximum of 15W under full loading.

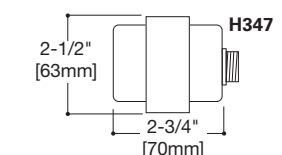
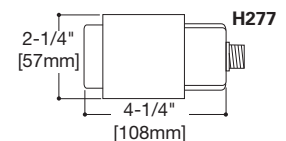

Protected / Non-insulated Soffits, Porches, and Canopies

Halo LED modules when used with Non-IC recessed housings in protected soffits, porches or canopies offers a solution for outdoor accent lighting without concern for typical outdoor temperatures found in both cold and warm climates. Halo LED is rated for continuous operation from -30°C to 40°C when used with H7T, H7TNB, H7RT, ET700, ET700R, H750T, H750TCP, H750TD010, H750RTD010 Series non-IC housings.

Multiple reflector and baffle options allow the Halo LED recessed luminaire to be used in many interior spaces. Choose the best reflector finish and trim for the interior space. Aesthetically pleasing regressed shower trim are available for applications requiring wet location listings.

494P06 White Reflector with White Trim Ring

- Halo matte white finish die-cast trim ring
- Halo matte white aluminum reflector
- Trim ring height of .160" at OD and .180" at ID
- Provides clearance for remodeler flange and gasket for AIR-TITE™ seal

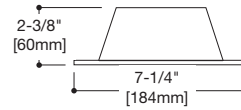

494P06
White Reflector
with White Trim Ring

494SC06 Specular Reflector with White Trim Ring

- Halo matte white finish die-cast trim ring
- Specular Clear aluminum reflector
- Trim ring height of .160" at OD and .180" at ID
- Provides clearance for remodeler flange and gasket for AIR-TITE™ seal

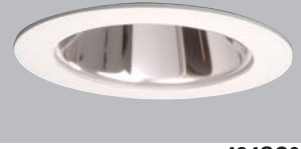
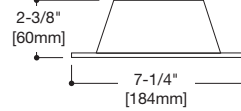

494SC06
Specular Reflector
with White Trim Ring

494H06 Haze Reflector with White Trim Ring

- Halo matte white finish die-cast trim ring
- Haze aluminum reflector
- Trim ring height of .160" at OD and .180" at ID
- Provides clearance for remodeler flange and gasket for AIR-TITE™ seal

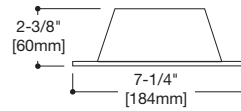

494H06
Haze Reflector
with White Trim Ring

494WB06 White Baffle with White Trim Ring

- Halo matte white finish die-cast trim ring
- Halo Matte White die-cast baffle
- Trim ring height of .160" at OD and .180" at ID
- Provides clearance for remodeler flange and gasket for AIR-TITE™ seal

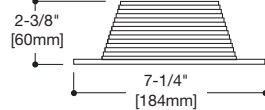

494WB06
White Baffle
with White Trim Ring

492PS06 Lensed Trim with White Baffle and Trim Ring

- Halo Matte White trim ring and baffle, regressed lens
- Wet location listed for use in showers and protected canopy applications
- Die-cast aluminum baffle and die-cast trim ring
- Frosted glass lens
- Trim height of .160" at OD & .180" at ID
- Provides clearance for remodeler flange and gasket for AIR-TITE™ seal

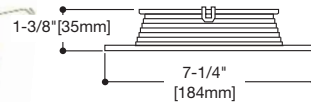

492PS06
Lensed White Baffle with
White Trim Ring



493WS06 Solite® Regressed Lens with White Baffle and White Trim Ring

- Halo matte white trim ring and baffle with Anti-Microbial finish standard
- Upper specular aluminum reflector for optical control and enhanced lumen delivery
- Wet location listed for use in showers and protected canopy applications
- Die-cast aluminum baffle and trim ring
- Trim height of .160" at OD & .180" at ID
- Provides clearance for remodeler flange and gasket for AIR-TITE™ seal

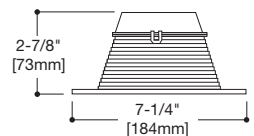

493WS06
Regressed Solite® Lensed
White Baffle with
White Trim Ring



ANTI-MICROBIAL finish

493SCS06 Solite® Regressed Lens with Specular Clear Reflector and White Trim Ring

- Halo matte white trim ring with specular clear reflector
- Upper specular aluminum reflector for optical control and enhanced lumen delivery
- Wet location listed for use in showers and protected canopy applications
- Die-cast aluminum reflector and trim ring
- Trim ring height of .160" at OD and .180" at ID
- Provides clearance for remodeler flange and gasket for AIR-TITE™ seal

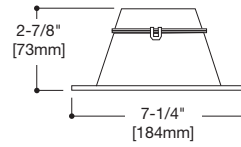

493SCS06
Regressed Solite® Lensed
Specular Reflector
with White Trim Ring



493HS06 Solite® Regressed Lens with Haze Reflector and White Trim Ring

- Halo matte white trim ring with Haze reflector
- Upper specular aluminum reflector for optical control and enhanced lumen delivery
- Wet location listed for use in showers and protected canopy applications
- Die-cast aluminum reflector and trim ring
- Trim ring height of .160" at OD and .180" at ID
- Provides clearance for remodeler flange and gasket for AIR-TITE™ seal

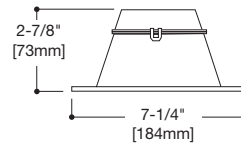

493HS06
Regressed Solite® Lensed
Haze Reflector
with White Trim Ring



493SNS06 Solite® Regressed Lens with Satin Nickel Reflector and Satin Nickel Trim Ring

- Halo Satin Nickel trim ring with Satin Nickel reflector
- Upper specular aluminum reflector for optical control and enhanced lumen delivery
- Wet location listed for use in showers and protected canopy applications
- Die-cast aluminum reflector and trim ring
- Trim ring height of .160" at OD and .180" at ID
- Provides clearance for remodeler flange and gasket for AIR-TITE™ seal

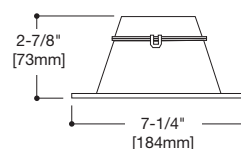

493SNS06
Regressed Solite® Lensed
Satin Nickel Reflector
with Satin Nickel
Trim Ring



493TBZS06 Solite® Regressed Lens with Tuscan Bronze Reflector and Tuscan Bronze Trim Ring

- Halo Tuscan Bronze trim ring with Tuscan Bronze reflector
- Upper specular aluminum reflector for optical control and enhanced lumen delivery
- Wet location listed for use in showers and protected canopy applications
- Die-cast aluminum reflector and trim ring
- Trim ring height of .160" at OD and .180" at ID
- Provides clearance for remodeler flange and gasket for AIR-TITE™ seal

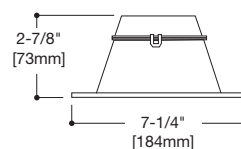

493TBZS06
Regressed Solite® Lensed
Tuscan Bronze Reflector
with Tuscan Bronze
Trim Ring



493BBS06 Solite® Regressed Lens with Black Baffle and White trim Ring

- Halo matte white trim ring with Black Baffle
- Upper specular aluminum reflector for optical control and enhanced lumen delivery
- Wet location listed for use in showers and protected canopy applications
- Die-cast aluminum baffle and trim ring
- Trim ring height of .160" at OD and .180" at ID
- Provides clearance for remodeler flange and gasket for AIR-TITE™ seal

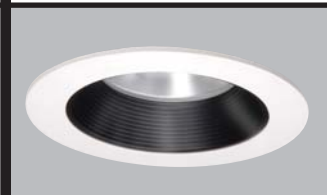
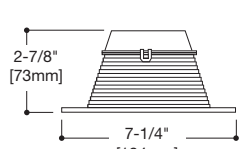

493BBS06
Regressed Solite® Lensed
Black Baffle with
White Trim Ring



Standard Dimming Control

Standard "incandescent type" 120V line voltage dimming is offered for the 600 Series LED. This is the most common type of dimming for residential and light commercial applications.

120VAC Standard Dimming - Incandescent and Magnetic Low Voltage Dimmers

Standard 120VAC line voltage dimmers for incandescent and magnetic low voltage loads control the light source with "forward phase control". With forward phase control the dimmer "chops" the forward part of the AC wave to deliver less or more power to the light source. Halo LED is generally compatible with this type of dimmer, but minimum load requirements of the dimmer may require four or more LEDs on the circuit. In addition, digital or smart versions of incandescent and magnetic low voltage dimmers are not compatible for circuits with LEDs only (digital versions of incandescent dimmers require an incandescent load on the circuit). The recommended dimmer for less than four LEDs and digital incandescent dimmer types is the electronic low voltage dimmer.

120VAC Standard Dimming - Electronic Low Voltage

Standard 120VAC line voltage dimmers for electronic low voltage loads control the light source with "reverse phase control". With reverse phase control the dimmer "chops" the back part of the AC wave to deliver less or more power to the light source. Halo LED is compatible with this type of dimmer providing there is a neutral connection on the dimmer (connected to neutral in the wallbox). An ELV dimmer can typically control a minimum of one LED on the circuit. In addition, digital or smart versions of electronic low voltage dimmers (with a neutral connection) are compatible for circuits with LEDs only. Therefore, an electronic low voltage is the recommended dimmer for less than four LEDs and when a digital type dimmer is desired.

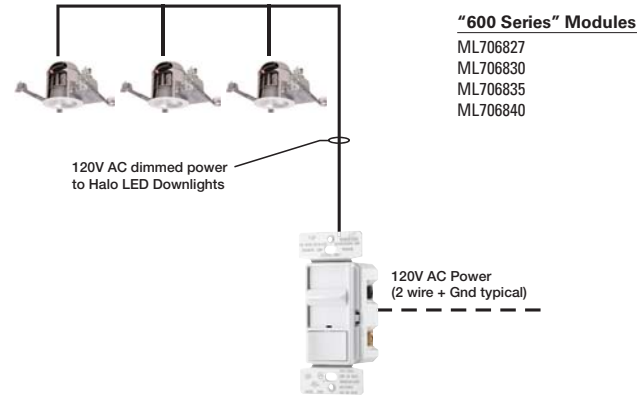

Electronic Low Voltage Digital and Analog Dimmers, Minimum Circuit Load of One LED Module, Dimming to 15% Requires a neutral in the wall box

Lutron*			
Diva	DVELV Series	Nova T	NTELV & NTLV Series
Maestro	MAELV Series	Skylark	SELV Series
Nova	NLV Series	Vierti	VTELV Series

Leviton

Acenti	ACE Series (Electronic low voltage dimmer with low end programmable trim from control panel for dimming to less than 5%)
Illumitech	IPE Series (Electronic low voltage dimmer with low end manual trim behind face plate for dimming to less than 5%)
Vizia +	VPE Series (Electronic low voltage dimmer with low end programmable trim from control panel for dimming to less than 5%)

* Refer to Lutron "LED Product Report Card" for additional information.

Incandescent / Magnetic Low Voltage Analog Standard Dimmers with Circuit Load of 4 LED Modules or More, Dimming to 15%

Cooper Wiring Devices

ASPIRE RF	N/A
ASPIRE	9530, 9532, 9538, 9540
Decorator Slide	DI06P, DI10P
Decorator Full-Slide	SI061, SI06P, SI10P
Toggle	6441, 6443, 6453
Rotary	6001, 6013, 6000, 6003, 6020, 6023
Architectural Rotary	RA110, RA115, RA120

Lutron

Ariadni	AY/TG Series	Lyneo	LX Series
Ceana	CN Series	Nova	N Series
Centurion	C Series	Nova T	NT/NTB/NTA Series
Dalia	DL Series	Qoto	Q Series
Diva	DV Series	Skylark	S Series
Glyder	GL Series		
Lumea	LG Series		

* Refer to Lutron "LED Product Report Card" for additional information.

Leviton

Illumitech	IPI/RPI Series	Trimatron	6681/6683/6602
Sureslide	663 Series		

Incandescent Dimmers with Minimum Brightness Adjustment (Low End Trim), Circuit Load of 4 LED Modules or More, Dimming to 5%

Leviton

Illumitech	IP10/IP40/IPM406/IPM10 Series dimmers
Acenti	ACI/ACE/ACX/ATI Series (Programmable trim)
Vizia +	VPI/VPE/VPX Series (Programmable trim)

Whole House Integrated Control Systems

Lutron*

Homeworks	HW-RPM-4A-120 Remote Power Module-Adaptive Dimming
	HW-RPM-4V-120 Remote Power Module-Dimming
	HWD-5NE, HRD-5NE Wired Maestro and RF Maestro Local Controls

* Refer to Lutron "LED Product Report Card" for additional information.

Commercial Integrated Control Systems

Lutron*

Commercial Panel Systems	LP-RPM-4A120 Remote Power Module - Adaptive Dimming
--------------------------	---

* Refer to Lutron "LED Product Report Card" for additional information.

SPECIAL NOTE: Incandescent Digital Dimmers (also called Smart or Multi-Location) require an incandescent load for circuit loads with LED modules only - use electronic low voltage dimmers, (Refer to Electronic Low Voltage dimmer matrix)

Cooper Wiring Devices

ASPIRE RF	RF9534-N, RF9534 (no neutral), RF9536-N, RF9536 (no neutral)
ASPIRE	9534, 9536
Smart	SM600, SM1000

Lutron

Abella	AB Series	Vareo	V Series
Faëdra	FA Series	Vierti	VT Series
Maestro	MA Series		
Spacer	SPS Series		

Leviton

Acenti	ACI Series	TrueTouch	6606/TTI Series
Mural	MDI/MSI Series	Vizia +	VPI Series
ToggleTouch	TGI Series		

Universal Wireless Dimmers (Incandescent, Magnetic Low Voltage, Electronic Low Voltage), Minimum Circuit Load of Two LED Modules, Dimming to 15%

Watt Stopper

Miro Universal	DRD4 Series Dimmers
	DCD267 Series Dimmers
	DCD68 (series multilocation - When used with DRD4 or DCD267 series master dimmers)

Incandescent Wireless Dimmers, Minimum Circuit Load of Five LED Modules, Dimming to 15%

A 15W minimum incandescent load or a neutral in the wall box are recommended to reliably dim

Watt Stopper

Miro Incandescent	DRD2 Series Dimmers
	DCD26 Series Dimmers
	DCD68 (series multilocation - When used with DRD2 or DCD26 series master dimmers)

Application Notes

- LED Dimming performance may vary from incandescent dimming. Performance results may vary based upon dimmer model, manufacturer, circuit wiring and circuit loading.
- Dimmer maximum load rating with LED may differ from published Incandescent and Electronic Low Voltage dimmer ratings. Consult dimmer manufacturer for maximum dimmer load with Halo LED.
- There are no warranties of performance or compatibility implied.

ORDERING INFORMATION

SAMPLE NUMBER: ML706827 494P06

Order LED Module and trim separately

600 Series LED Module			Trim Options	Accessories <i>(see product details for application information)</i>
ML706	8	27		
ML706 = 6" LED Module 600 Series LED	8 =80 CRI	27 =2725°K 30=3045°K 35=3465°K 40=3985°K	<p>494P06=Matte White Reflector/ white die cast trim ring.</p> <p>494WB06=White Baffle/ white die cast trim ring.</p> <p>494H06=Haze Reflector/ white die cast trim ring.</p> <p>494SC06=Specular Reflector/ white die cast trim ring.</p> <p>492PS06=Regressed Lens, white die-cast baffle and trim ring. Shower rated.</p> <p>493WBS06=Solite® Regressed Lens, upper reflector, White die-cast baffle and White die-cast trim ring with anti-microbial paint (standard). Shower Rated.</p> <p>493SCS06=Solite® Regressed Lens, upper reflector, Specular Clear die-cast reflector and die-cast white trim ring. Shower Rated.</p> <p>493HS06=Solite® Regressed Lens, upper reflector, Haze die-cast reflector, and white die-cast trim ring. Shower Rated.</p> <p>493SNS06=Solite® regressed Lens, upper reflector, Satin Nickel die cast reflector and Satin Nickel die-cast trim ring. Shower Rated.</p> <p>493TBZS06=Solite® Regressed Lens, upper reflector, Tuscan Bronze die-cast reflector and Tuscan Bronze die-cast trim ring. Shower Rated.</p> <p>493BBS06=Solite® Regressed Lens, Black die-cast baffle with die-cast white trim ring. Shower Rated.</p>	<p>OT400P=Oversize White Metal Trim Ring 6" ID x 9-1/4" OD</p> <p>OT403P=Oversize White Plastic Trim Ring 6" ID x 8" OD</p> <p>H277=Transformer - Steps 277 line voltage down to 120V</p> <p>H347=Transformer - Steps 347 line voltage down to 120V</p> <p>Thin Profile Trim Rings:</p> <p>TRM490WH=Thin Profile matte white die-cast trim ring</p> <p>TRM490SN=Thin Profile Satin Nickel die-cast trim ring</p> <p>TRM490TBZ=Thin Profile Tuscan Bronze die-cast trim ring</p> <p>TRM490BK=Thin Profile Black die-cast trim ring</p> <p>TRM490PC=Thin Profile Polished Chrome die-cast trim ring</p> <p>ML7RAB=Retrofit Adapter Band for Housings without Torsion Spring Receivers. The ML7RAB kit supplies parts to retrofit four housings; the kit includes: 4 - Retrofit Adapter Bands with screws and locking wire nuts.</p>

3 YEAR PRODUCT LIMITED WARRANTY

Cooper Lighting (The Company) warrants the HALO ML7068xx LED Modules, HALO H750x Series housings and HALO LED trims against defects in material or workmanship for a period of three years from date of original purchase, and agrees to repair or, at the company's option, replace a defective product without charge for either replacement parts or labor during such time. This does not include labor to remove or install fixtures. If used in recessed housings other than Halo or ALL-Pro, the Cooper Lighting 3-year warranty applies to the LED Module and trim only.

This warranty is extended only to the original purchaser of the product. A purchasers receipt or other proof of date of original purchase acceptable to the Company is required before warranty performance shall be rendered.

This warranty only covers product failure due to defects in materials or workmanship which occurs in normal use. It does not cover the failure of product caused by accident, misuse, abuse, lack of reasonable care, alteration, or faulty installation, subjecting the product to any but the specified electrical service or any other failure not resulting from defects in materials or

workmanship. Damage to the product caused by separately purchased, non-Company supplied components and corrosion or discoloration of components are not covered by this warranty. There are no express warranties except as described above.

THE COMPANY SHALL NOT BE LIABLE FOR INCIDENTAL, SPECIAL OR CONSEQUENTIAL DAMAGES RESULTING FROM THE USE OF THE PRODUCT OR ARISING OUT OF ANY BREACH OF THIS WARRANTY. ALL IMPLIED WARRANTIES OF MERCHANTABILITY AND FITNESS FOR A PARTICULAR PURPOSE, ARE LIMITED IN DURATION TO THE DURATION OF THIS EXPRESS WARRANTY. Some states do not allow the exclusion or limitation of incidental or consequential damages, or limitations on how long an implied warranty lasts, so the above exclusions or limitations may not apply to you.

No other warranty, written or verbal, is authorized by the Company. This warranty gives you specific legal rights, and you may also have other rights which vary from state to state.

To obtain warranty service, please write to Cooper Lighting, 1121 Highway 74 South, Peachtree City, Georgia 30269. Enclose product model number and problems you are experiencing, along with address and telephone number. You will then be contacted with a solution or a Return Goods Authorization number and full instructions for returning the product. All returned products must be accompanied by a Return Goods Authorization Number issued by the Company and must be returned freight prepaid. Any product received without a Return Goods Authorization Number from the Company will be refused.

Cooper Lighting is not responsible for merchandise damaged in transit. Repaired or replaced products shall be subject to the terms of this warranty and are inspected when packed. Evident or concealed damage that is made in transit should be reported at once to the carrier making the delivery and a claim filed with them.

Solite® is a registered trademark of AGC Flat Glass North America